

Raymarine[®]

ST40 Bidata Instrument Owner's Handbook

Document number: 81159-3
Date: March 2006

Important information

Safety notices



WARNING: Product installation & operation

This equipment must be installed and operated in accordance with the Raymarine instructions provided. Failure to do so could result in personal injury, damage to your boat and/or poor product performance.



WARNING: Electrical safety

Make sure you have switched off the power supply before you start installing this product.



WARNING: Navigation aid

Although we have designed this product to be accurate and reliable, many factors can affect its performance. Therefore, it should serve only as an aid to navigation and should never replace commonsense and navigational judgement. Always maintain a permanent watch so you can respond to situations as they develop.

EMC conformance

All Raymarine equipment and accessories are designed to the best industry standards for use in the recreational marine environment.

The design and manufacture of Raymarine equipment and accessories conform to the appropriate Electromagnetic Compatibility (EMC) standards, but correct installation is required to ensure that performance is not compromised.

Waste from Electrical and Electronic Equipment (WEEE) Directive



The Waste from Electrical and Electronic Equipment (WEEE) Directive requires the recycling of waste electrical and electronic equipment. Whilst the WEEE Directive does not apply to some of Raymarine's products, we support its policy and ask you to be aware of how to dispose of this product.

The crossed out wheellie bin symbol, illustrated above, and found on our products signifies that this product should not be disposed of in general waste or landfill.

Please contact your local dealer, national distributor or Raymarine Technical Services for information on product disposal.

Handbook information

To the best of our knowledge, the information in this handbook was correct when it went to press. However, Raymarine cannot accept liability for any inaccuracies or omissions it may contain.

In addition, our policy of continuous product improvement may change specifications without notice. Therefore, Raymarine cannot accept liability for any differences between the product and the handbook.

Contents

Important information	i
WARNING	i
EMC conformance	i
Handbook information	i
Preface	v
Parts supplied	vi
Chapter 1: Operation	1
1.1 Introduction	1
Display	1
1.2 Operating procedures	2
Display action	2
Silencing alarms	2
1.3 Alarms	7
Alarm indications	7
Shallow alarm	7
Deep alarm	7
Anchor alarms	7
Enabling/disabling alarms	8
Chapter 2: Maintenance and Fault Finding	9
2.1 Maintenance	9
Servicing and safety	9
Instrument	9
Transducer	10
Cabling	10
2.2 Fault finding	10
Preliminary procedures	10
Fixing faults	10
Assistance	13

Chapter 3: Installation	15
3.1 Planning your installation	15
EMC installation guidelines	15
Suppression Ferrites	16
Connections to Other Equipment	16
Tools required	16
Site requirements	17
Transducers	17
Instrument	19
3.2 Procedures	20
Fitting transducers	20
Running transducer cable	20
Connections to the instrument	21
Stand-alone connections	22
SeaTalk connections	23
Fitting the instrument	23
Desktop Mounting Bracket	25
3.3 Calibration requirement	26
Chapter 4: Calibration	27
4.1 Introduction	27
EMC conformance	27
4.2 User calibration	27
Depth offsets	31
4.3 Intermediate calibration	31
4.4 Dealer calibration	32
Instrument Specification	35
Glossary	37
Index	39

Preface

Thank you for purchasing a Raymarine product. We are sure your ST40 instrument will give you many years of trouble-free operation.

This instrument is designed to provide reliable performance, even under the most demanding conditions.

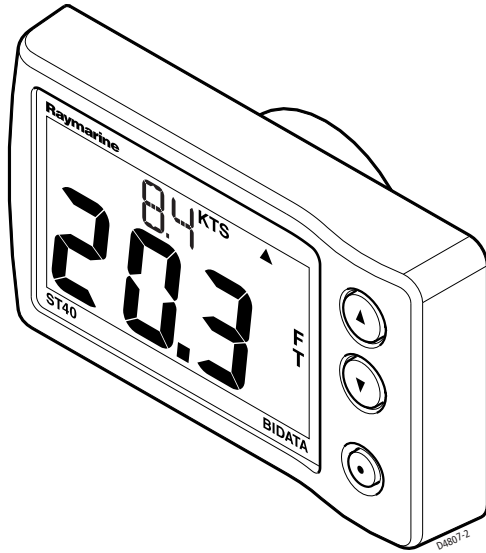

Parts supplied

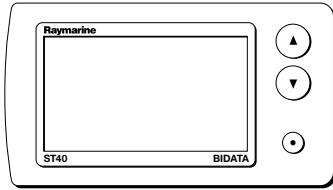

ST40 Bidata instrument

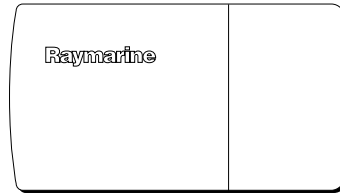

Instrument Cover

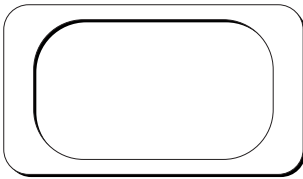

Gasket

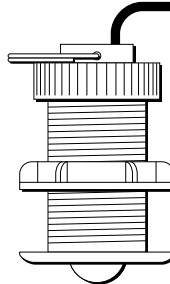

Retractable speed transducer
Supplied with bung
(not illustrated)

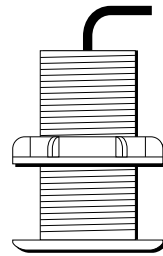

Depth transducer

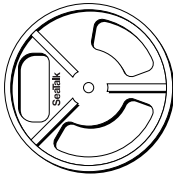

Clamping bracket

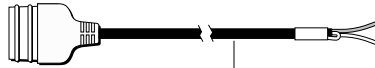

1 m (3 ft) power cable

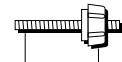

Fixing stud
Thumb nut

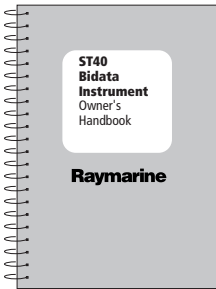

Owner's Handbook.
Warranty document and fitting
templates included in Handbook

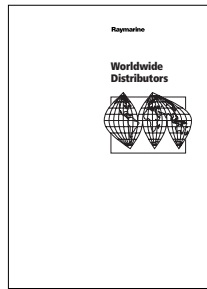

Worldwide Service Centre
Handbook.

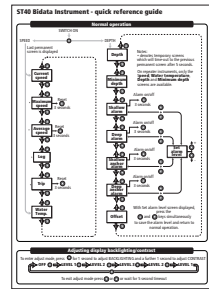

Quick Reference Guide

Note:

The items shown here are supplied for an ST40 Bidata system. If an instrument is purchased separately, transducers are not included. If any item is not present, contact your Raymarine Dealer.

Chapter 1: Operation

1.1 Introduction

Your ST40 Bidata instrument:

- Provides speed information (current, maximum and average), in either knots (KTS), miles per hour (MPH) or kilometres per hour (KPH).
- Provides log and trip information. These are given in either nautical miles (NM), statute miles (M) or kilometres (KM).
- Provides water temperature information. This is given in either degrees Celsius (°C) or degrees Fahrenheit (°F).
- Provides depth information in either feet (FT), metres (M) or fathoms (FA).
- Records the minimum depth encountered during the period it is switched on. You can reset this at any time.
- Enables you to define alarm thresholds for shallow water, deep water, shallow anchor and deep anchor.
- Enables you to see what offset is applied to the depth reading.

Note: *The required speed, distance, depth and water temperature units are selected during User calibration (see Chapter 4, Calibration).*

CAUTION

Your instrument is calibrated to factory (default) settings when first supplied and must therefore be calibrated before use, to ensure optimum performance on your vessel. Do NOT use the instrument until the calibration procedures have been satisfactorily completed, using the procedures in Chapter 4, Calibration.

Coloured bezel and Desktop Mounting Bracket options are available for your ST40 instrument. Contact your Raymarine dealer for further information.

Display

The ST40 Bidata display comprises upper and lower data areas, each of which shows either depth or speed information, selected as shown in the following illustration.

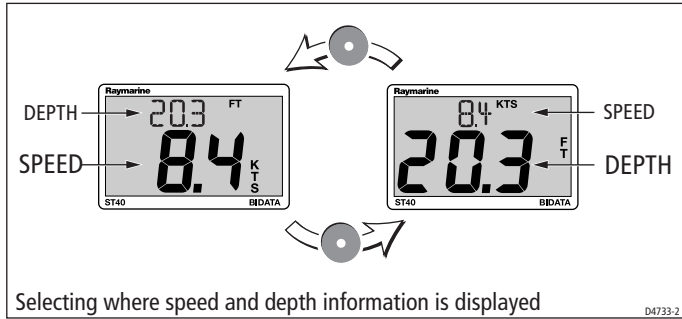

1.2 Operating procedures

Operating information is presented in flow chart form. The flow charts show the various operating screens and key presses necessary to carry out the various instrument functions. Key presses are momentary unless otherwise stated. Note that:

- Up/down depth-trend arrows are displayed, if the seabed is rising or falling at a significant rate.
- The minimum depth reading is reset to zero at power up.
- The maximum speed reading is reset to zero at power up.
- The average speed reading is reset to zero at power up.
- The Log screen shows the total distance covered by the vessel since the ST40 Bidata instrument was fitted.
- The trip reading is reset to zero at power up.

Display action

During normal operation (see *Normal operation* flow charts), the **Speed**, **Depth** and **Water temperature** screens are permanent screens, i.e. once one of these is selected, it will remain until another screen is manually selected. All other screens are temporary and after 5 seconds, will time out to the permanent screen which was last displayed for 5 seconds or more.

Silencing alarms

To silence an alarm (see the *Alarms* section, later in this chapter), momentarily press any one of the instrument keys.

NORMAL OPERATION (sheet 1)

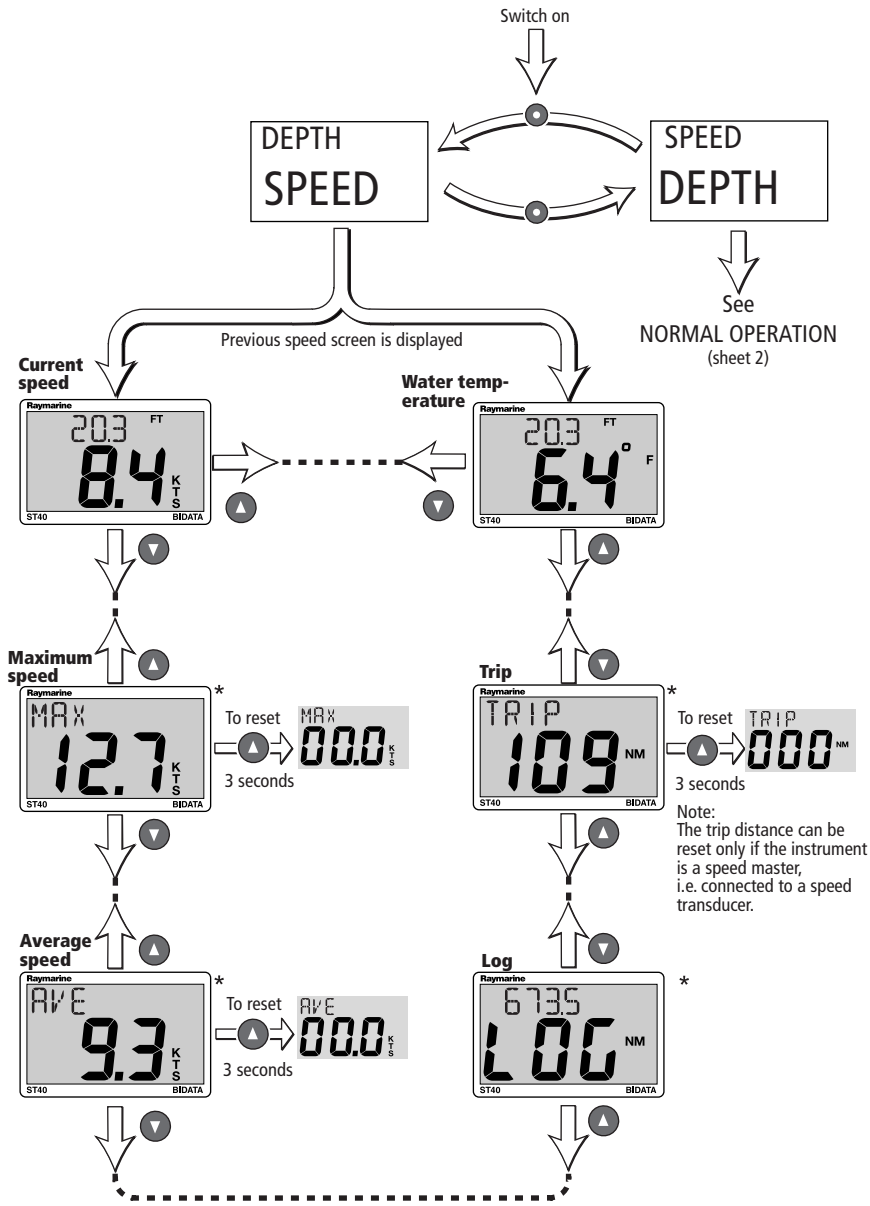

Note: Screens annotated with * are temporary and will time-out to the previous permanent screen after 5 seconds.

NORMAL OPERATION (sheet 2)

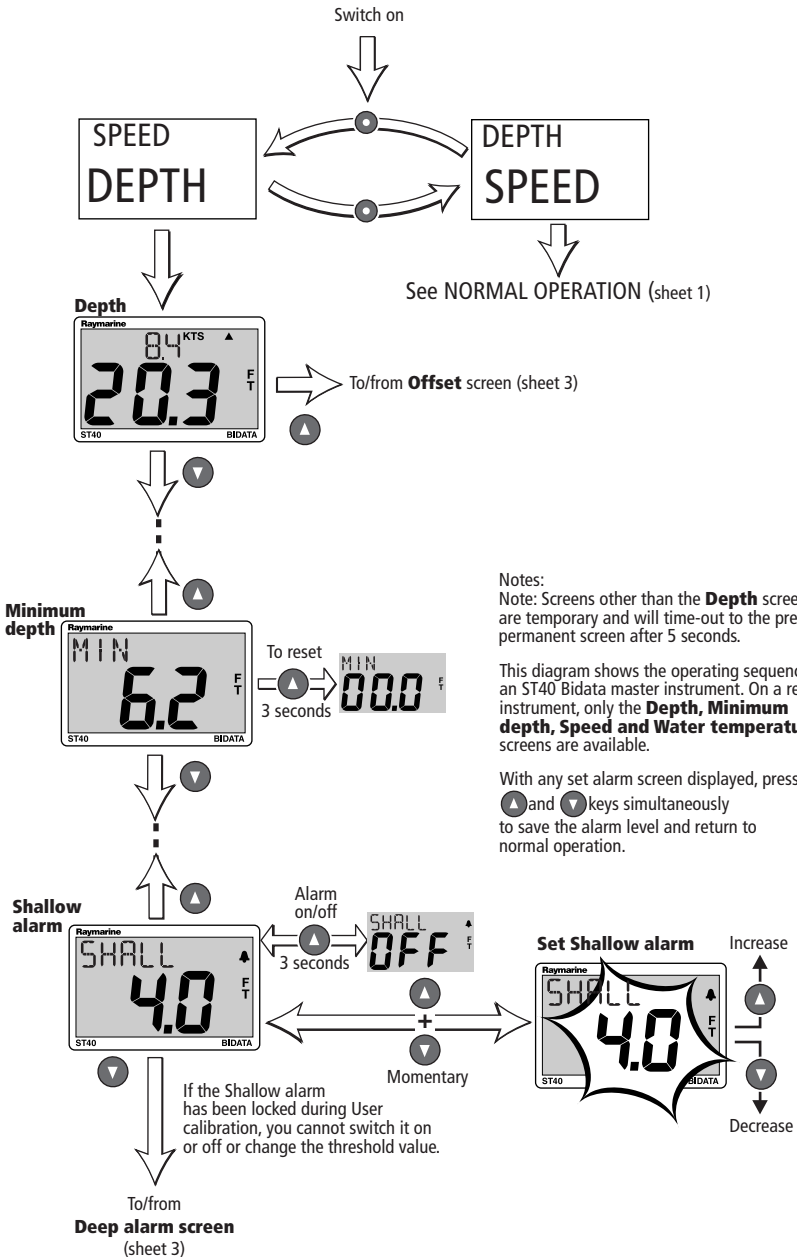

See NORMAL OPERATION (sheet 1)

To/from **Offset** screen (sheet 3)

To reset
3 seconds

Alarm on/off
3 seconds

Momentary

If the Shallow alarm has been locked during User calibration, you cannot switch it on or off or change the threshold value.

To/from **Deep alarm screen** (sheet 3)

Notes:
Note: Screens other than the **Depth** screen, are temporary and will time-out to the previous permanent screen after 5 seconds.

This diagram shows the operating sequence for an ST40 Bidata master instrument. On a repeater instrument, only the **Depth, Minimum depth, Speed and Water temperature** screens are available.

With any set alarm screen displayed, press the **▲** and **▼** keys simultaneously to save the alarm level and return to normal operation.

NORMAL OPERATION (sheet 3)

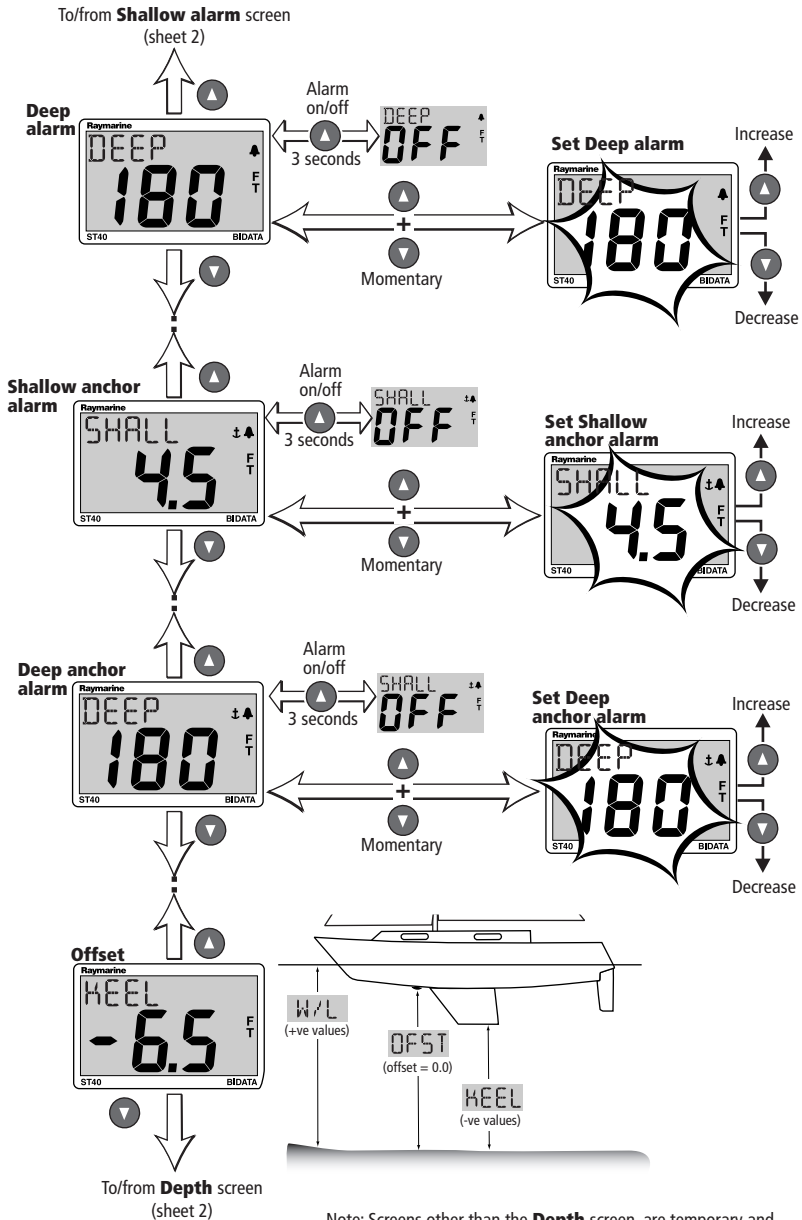

Note: Screens other than the **Depth** screen, are temporary and will time-out to the previous permanent screen after 5 seconds.

Adjusting display backlighting and contrast

Hold down  for 1 second to enter Adjust Backlight mode

for 2 seconds to move through Adjust Backlight mode and enter Adjust Contrast mode

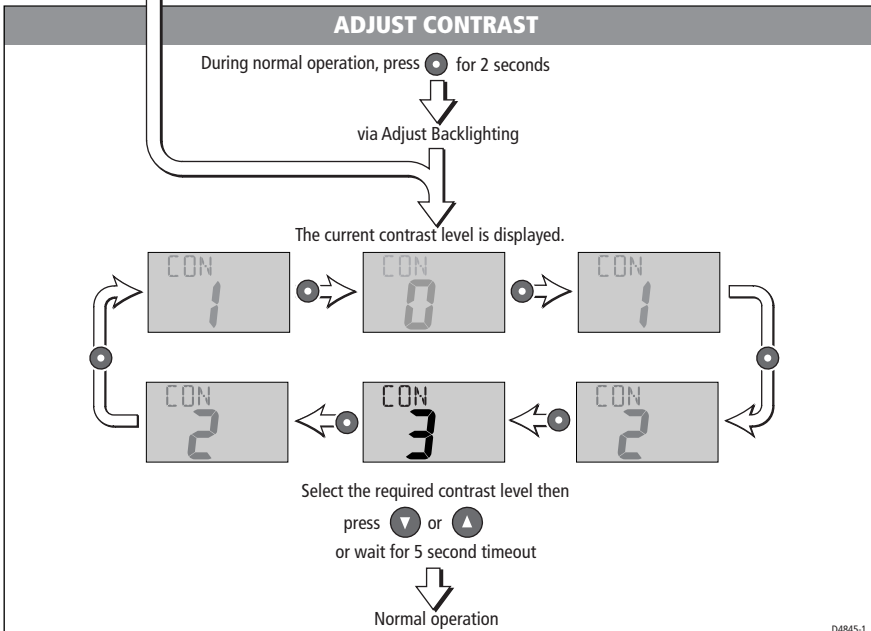
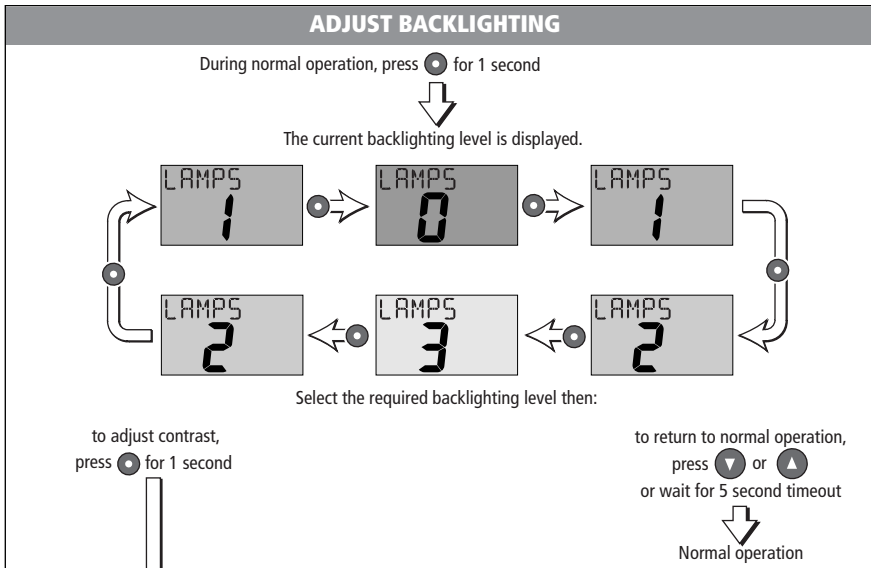

1.3 Alarms

Alarm indications

Shallow alarm

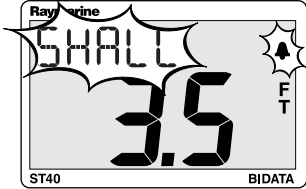

The display shows the word "SHALL" in a jagged, comic-style font at the top. Below it, the number "3.5" is displayed in a large, bold, digital font. To the right of the number, the letters "FT" are stacked vertically. The display is framed by a thin border with "ST40" at the bottom left and "BIDATA" at the bottom right. A small bell icon is in the top right corner. To the right of the display is a plus sign and a speaker icon with sound waves.

Depth is equal to or less than the shallow alarm threshold.
Alarm continues until cancelled manually.

D4666-2

Deep alarm

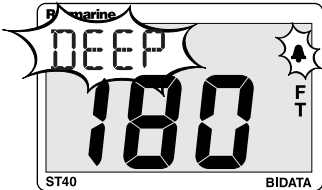

The display shows the word "DEEP" in a jagged, comic-style font at the top. Below it, the number "180" is displayed in a large, bold, digital font. To the right of the number, the letters "FT" are stacked vertically. The display is framed by a thin border with "ST40" at the bottom left and "BIDATA" at the bottom right. A small bell icon is in the top right corner. To the right of the display is a plus sign and a speaker icon with sound waves.

Triggered by depths equal to the deep alarm threshold. Continues until cancelled manually.

D4789_2

Anchor alarms

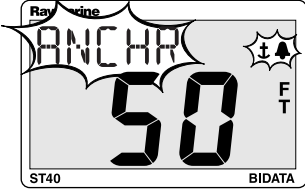

The display shows the word "ANCHR" in a jagged, comic-style font at the top. Below it, the number "50" is displayed in a large, bold, digital font. To the right of the number, the letters "FT" are stacked vertically. The display is framed by a thin border with "ST40" at the bottom left and "BIDATA" at the bottom right. A small bell icon is in the top right corner. To the right of the display is a plus sign and a speaker icon with sound waves.

Depth is either:
equal to or less than the shallow anchor alarm threshold
or
equal to or more than the deep anchor alarm threshold

D4790-2

Enabling/disabling alarms

You can enable or disable any alarm function (i.e. switch it on or off) by selecting the relevant alarm screen (see *Normal operation*) and holding down the  key for 3 seconds (toggle action).

Chapter 2: Maintenance and Fault Finding

2.1 Maintenance

Servicing and safety

- Raymarine equipment should be serviced only by authorised Raymarine service technicians. They will ensure that service procedures and replacement parts used will not affect performance. There are no user-serviceable parts in any Raymarine product.
- Some products generate high voltages, so never handle the cables/connectors when power is being supplied to the equipment.
- When powered up, all electrical equipment produces electromagnetic fields. These can cause adjacent pieces of electrical equipment to interact with one another, with a consequent adverse affect on operation. In order to minimise these effects and enable you to get the best possible performance from your Raymarine equipment, guidelines are given in the installation instructions, to enable you to ensure minimum interaction between different items of equipment, i.e. ensure optimum Electromagnetic Compatibility (EMC).
- Always report any EMC-related problem to your nearest Raymarine dealer. We will use any such information to improve our quality standards.
- In some installations, it may not be possible to prevent the equipment from being affected by external influences. In general this will not damage the equipment but it can lead to spurious resetting action, or momentarily may result in faulty operation.
- Always switch off the power to Raymarine equipment before working on it.

When requesting service, please quote equipment Type, Model Number, Serial Number and, if possible, Software Release Issue. The Software Release Issue can be ascertained by means of the Intermediate Calibration facility, see *Chapter 4, Calibration*.

Instrument

Certain atmospheric conditions may cause a small amount of condensation to form on the instrument window. This will not harm the instrument and will clear after the instrument has been switched on for a short period.

Periodically clean your ST40 instrument with a soft damp cloth. Do NOT use chemical or abrasive materials to clean the instrument.

Transducers

Refer to the Installation and Maintenance instructions supplied with the transducers.

Cabling

Examine all cables for chafing or other damage to the outer shield and, where necessary, replace and re-secure.

2.2 Fault finding

Preliminary procedures

If you appear to have a problem, first check the security of the connections at the rear of the instrument and reconnect any that are loose.

Changes in the electronic environment may adversely affect the operation of your ST40 equipment. Typical examples of such changes are:

- Electrical equipment has recently been installed or moved aboard your vessel.
- You are in the vicinity of another vessel or shore station emitting radio signals.

Fixing faults

All Raymarine products are subjected to comprehensive test and quality assurance programmes prior to packing and shipping. However, if a fault occurs, the following guidelines may help to identify and rectify the problem.

Low battery

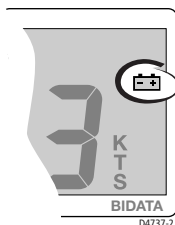

Action

Recharge your vessel's battery as soon as possible

Display blank

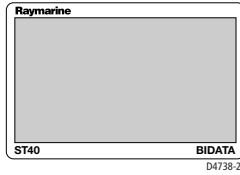

Action

Check fuse/circuit breaker.

Check power supply.

Check SeaTalk cabling and connector security.

Depth reading flashes when under way

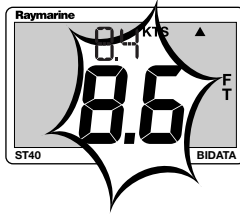

OR

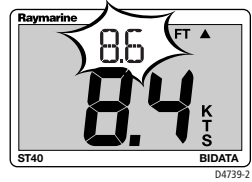

Action

Ensure that reading stabilises when clear of disturbed water, e.g. boat wakes, propeller wash etc.

No depth information

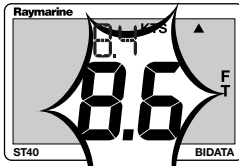

OR

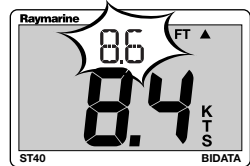

1 minute

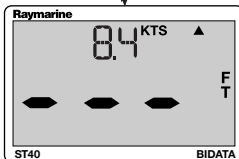

1 minute

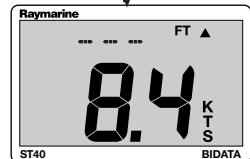

Action

Check the condition of the depth transducer cable and the security of the connections.

Could also be due to weed growing on the transducer face.

No speed or temperature information

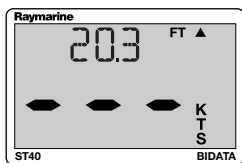

OR

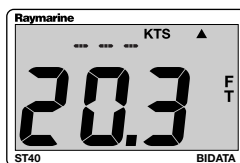

and

and

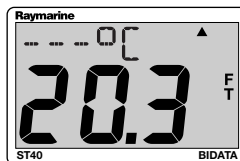
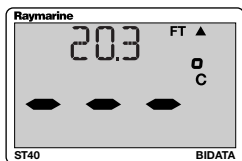

D4741-3

Action

Check the condition of the speed transducer cable and the security of the connections.

No speed information but temperature information is present

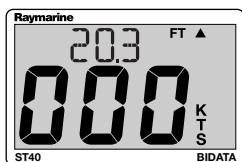

OR

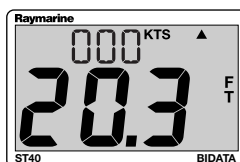

and

and

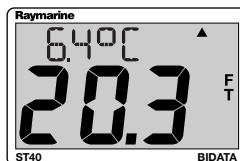
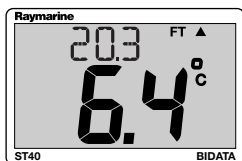

D4742-2

Action

CAUTION

If you need to remove the transducer insert, have the transducer bung to hand and secure it in the transducer body immediately after the insert has been removed, to prevent excessive ingress of water.

The speed transducer paddle wheel may be fouled. Clean the paddle wheel.

SeaTalk information not being transferred between instruments

For example, backlighting level changes implemented at one instrument do not affect other instruments

Action

Check security of SeaTalk connections between instruments.

Check condition of SeaTalk cables.

Isolate faulty instrument by disconnecting instruments one by one.

A group of SeaTalk instruments not working

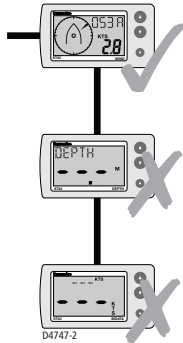

Action

Check the security of SeaTalk connectors between functioning and non-functioning instruments.

Assistance

If you are unable to rectify any problem, please contact your local Raymarine Dealer for assistance.

Chapter 3: Installation

This chapter describes how to install the ST40 Bidata instrument, and associated transducers. The transducers are fitted in the hull of the vessel and is connected to the rear of the instrument.

3.1 Planning your installation

Determine the best positions for both transducer and instrument, such that the *EMC installation guidelines* and the *Site requirements* (below) are satisfied.

EMC installation guidelines

All Raymarine equipment and accessories are designed to the best industry standards for use in the leisure marine environment.

Their design and manufacture conform to the appropriate Electromagnetic Compatibility (EMC) standards, but correct installation is required to ensure that performance is not compromised. Although every effort has been taken to ensure that they will perform under all conditions, it is important to understand what factors could affect the operation of the product.

The guidelines given here describe the conditions for optimum EMC performance, but it is recognised that it may not be possible to meet all of these conditions in all situations. To ensure the best possible conditions for EMC performance within the constraints imposed by any location, always ensure the maximum separation possible between different items of electrical equipment.

For **optimum** EMC performance, it is recommended that **wherever possible**:

- All Raymarine equipment and cables connected to it are:
 - At least 1 m (3 feet) from any equipment transmitting or cables carrying radio signals e.g. VHF radios, cables and antennas. In the case of SSB radios, the distance should be increased to 2 m (7 ft).
 - More than 2 m (7 ft) from the path of a radar beam. A radar beam can normally be assumed to spread 20 degrees above and below the radiating element.

- The equipment is supplied from a different battery from that used for engine start. Voltage drops below 10 V in the power supply to our products, and starter motor transients, can cause the equipment to reset. This will not damage the equipment, but may cause the loss of some information and may change the operating mode.
- Raymarine specified cables are used at all times. Cutting and rejoining these cables can compromise EMC performance and so must be avoided unless doing so is detailed in the installation manual.
- If a suppression ferrite is attached to a cable, this ferrite should not be removed. If the ferrite needs to be removed during installation it must be reassembled in the same position.

Suppression Ferrites

The following illustration shows typical cable suppression ferrites fitted to Raymarine equipment. Always use the ferrites supplied by Raymarine.

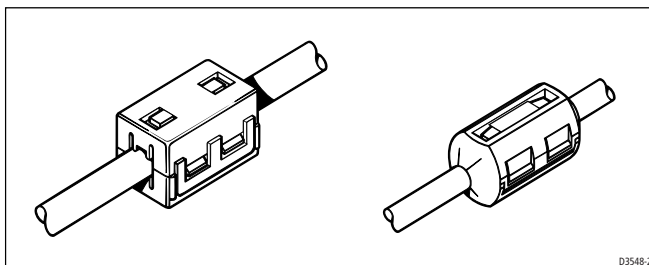

Connections to Other Equipment

If your Raymarine equipment is going to be connected to other equipment using a cable not supplied by Raymarine, a suppression ferrite **MUST** always be fitted to the cable close to the Raymarine unit.

Tools required

The tools required for fitting the standard ST40 instrument system are shown in the following illustration.

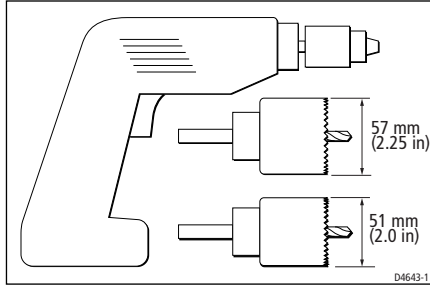

Note: *If you intend fitting a nonstandard transducer, extra tools may be required*

Site requirements

Transducers

The transducer types required for the various hull types are as follows:

Hull material	Speed transducer	Depth transducer
GRP	M78712 Through hull plastic (supplied as standard)	M78713 through hull plastic (supplied as standard) or
Steel		M78718 Retractable through hull
Aluminium		
Wood	M78716 Through hull bronze	M78714 Through hull bronze

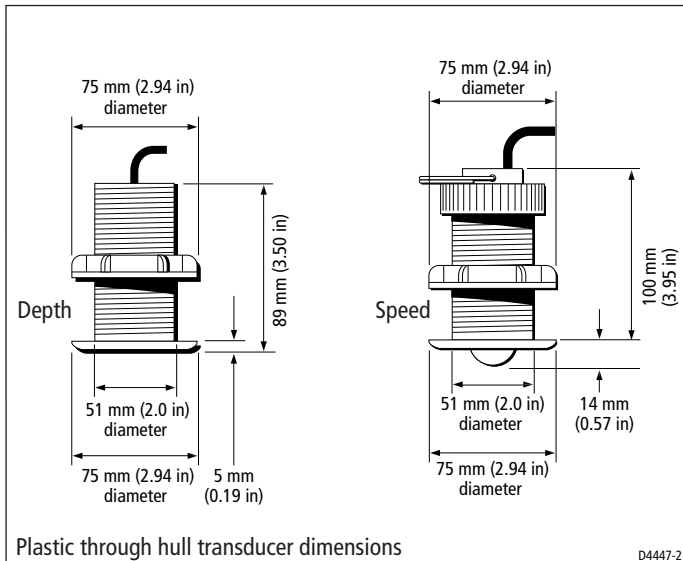

D4447-2

Other transducer types are available for specific requirements. For further details, contact your local Raymarine dealer.

The transducers should be sited within the clear water flow areas indicated by the shaded areas below.

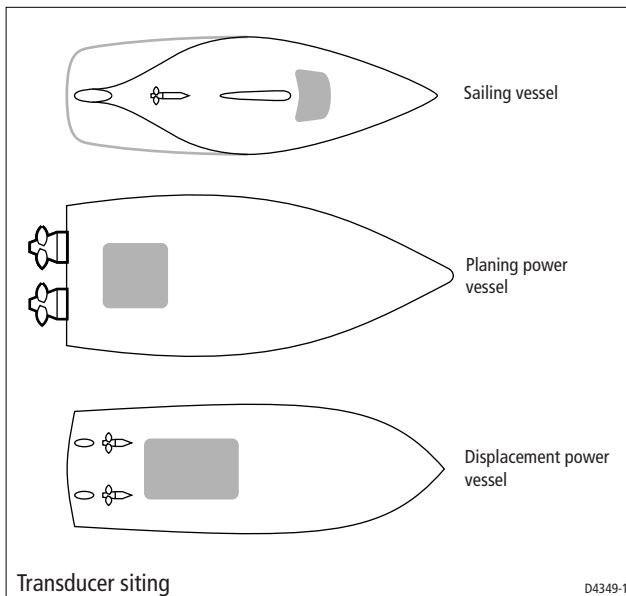

Each transducer should also:

- Be ahead of the propellers (by a minimum of 10% of the water line length).
- Be at least 150 mm (6 in) away from the keel (ideally ahead of the keel if a sailing yacht).
- Be as near as possible to the centre line of the vessel.
- Be clear of other through-hull fittings or projections.
- Have sufficient clearance inside the hull to fit the nut.
- Have 100 mm (4 in) of headroom to allow for withdrawal.

In addition to the above requirements, the depth transducer must be mounted within 10° of the vertical, forward, aft and athwart ships.

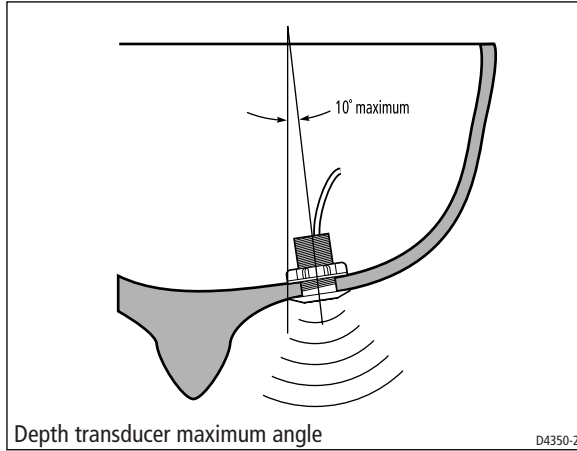

Instrument

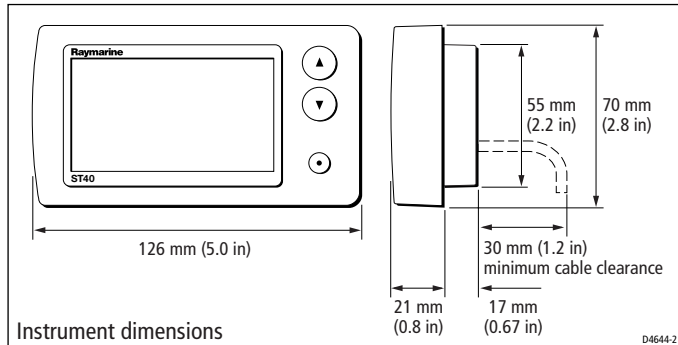

CAUTION:

The presence of moisture at the rear of the instrument could cause damage either by entering the instrument through the breathing hole or by coming into contact with the electrical connectors.

Each instrument must be positioned where:

- It is easily read by the helmsman or navigator
- It is protected against physical damage
- It is at least 230 mm (9 in) from a compass
- There is reasonable rear access for installation and servicing
- The rear of the instrument is protected from water.

3.2 Procedures

Adapt these procedures as appropriate, to suit your individual requirement.

CAUTION:

Where it is necessary to cut holes (e.g. for cable routing and instrument mounting), ensure that these will not cause a hazard by weakening critical parts of the vessel's structure. If in doubt, seek the advice of a reputable boat builder.

Fitting transducers

Instructions for installing and maintaining the speed and depth transducers are packed with them. Before attempting to install the transducers, read these instructions and the *Site requirements* for transducers described in this Chapter.

Running transducer cable

Each transducer type has a 9 m (30 ft) cable fitted with spade terminals for connection to the ST40 Bidata instrument. Observing the following guidelines, run the cable to the instrument:

- If the cable has to be fed through the deck, always use a good quality deck gland.
- Where cables are fed through holes, always use grommets to prevent chafing.
- Secure long cable runs so they do not present a hazard.
- Wherever possible, route the cable away from fluorescent lights, engines, radio transmitting equipment, as these may cause interference.

Important point: Do NOT shorten the cable from the depth transducer as this will seriously degrade transducer performance.

Connections to the instrument

You can connect your instrument:

- Directly to the speed and depth transducers as a stand-alone master instrument. When connected in this manner, the instrument must be connected to a suitable power source using the 1 m (3 ft) power cable provided.
- As part of a SeaTalk system either as a repeater or, with a transducer also connected as a system master. To connect to SeaTalk, you will need an additional SeaTalk Interconnection Kit (Part No. E25028). When connected in this manner, power can be provided from the SeaTalk bus (e.g. from the autopilot).

You can also connect the instrument to the speed and depth transducers and to SeaTalk. When thus connected, the instrument will be the master speed and depth instrument for the SeaTalk system.

If it is necessary to fit spade connectors to the transducer cable, do so as shown in the following illustration. Prepare the cable, as at (a), and fit the spade connectors, as at (b). When fitting each spade connector, ensure that wire strands do not extend beyond the rear of the spade connector insulation.

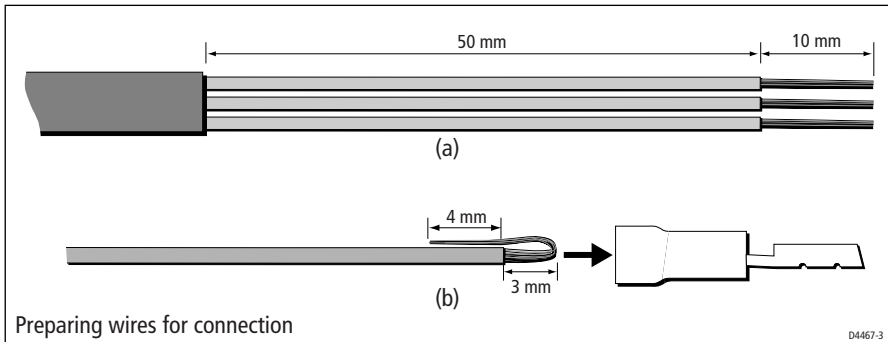

Preparing wires for connection

D4467-3

Stand-alone connections

CAUTION

Ensure that the power supply for each stand-alone ST40 instrument is protected by a 3 A fuse or circuit breaker.

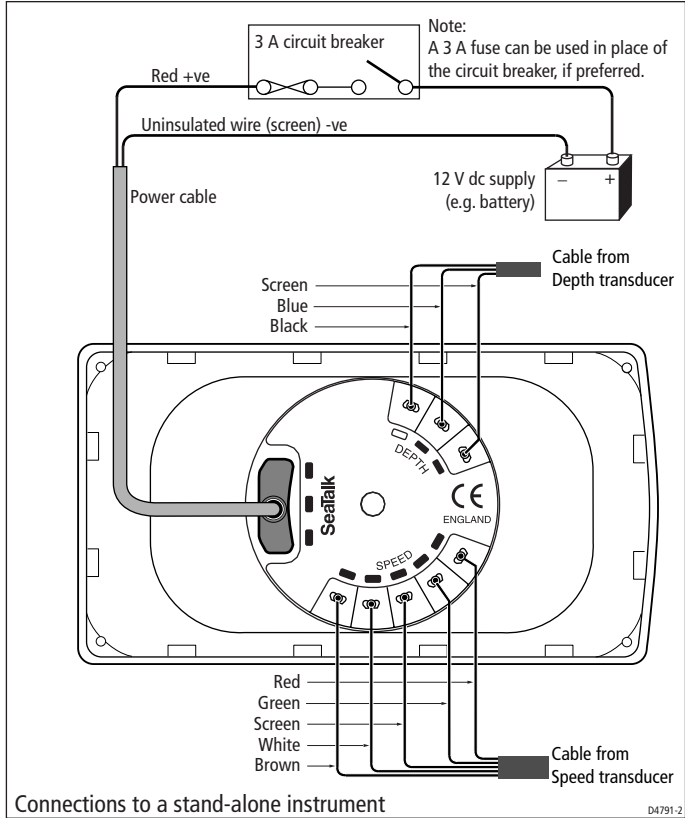

SeaTalk connections

CAUTION

When instruments are connected to SeaTalk, ensure that the power supply for the SeaTalk 12 V line is protected by a 5 A fuse or circuit breaker.

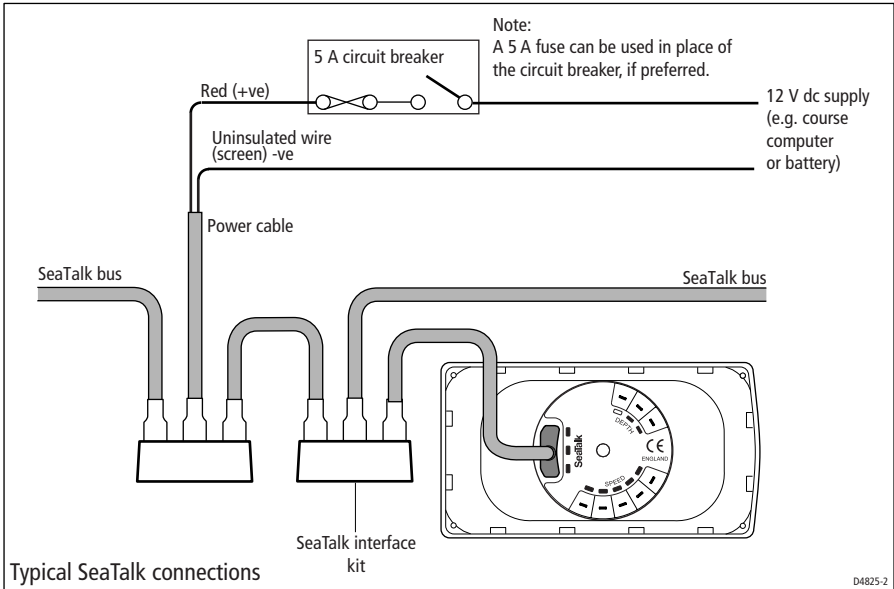

Fitting the instrument

Fit your ST40 instrument as shown in the following illustrations.

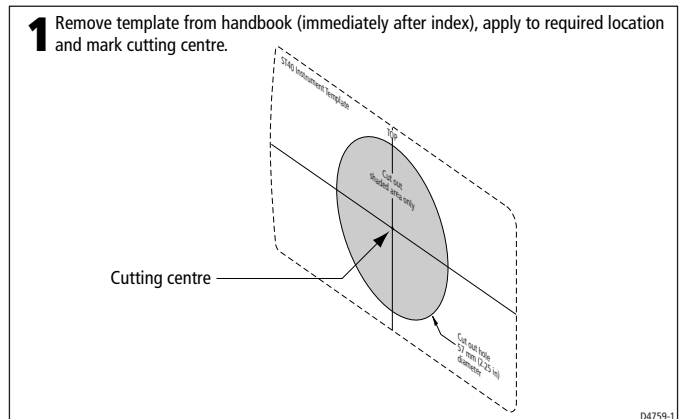

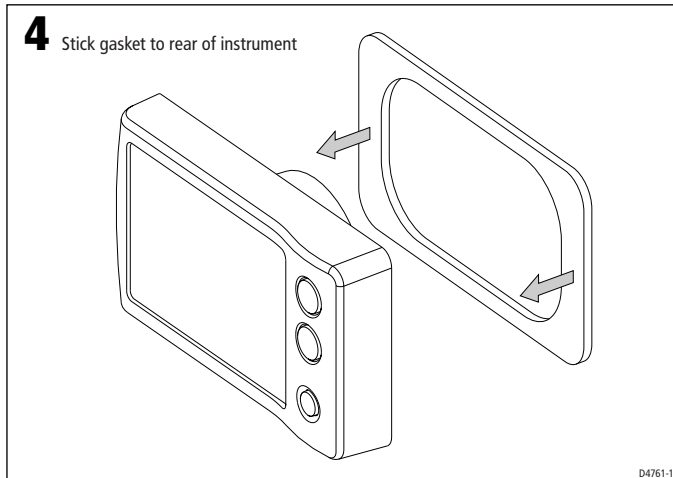
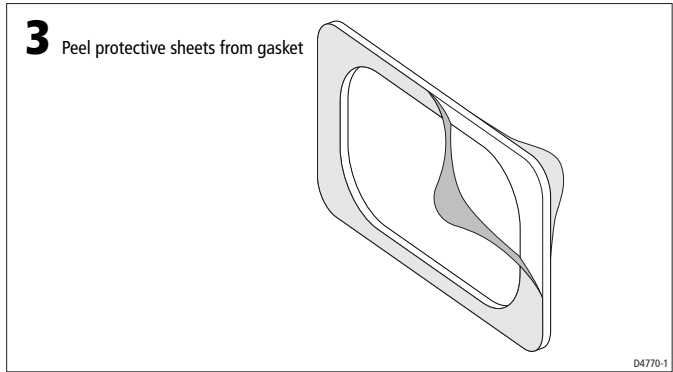
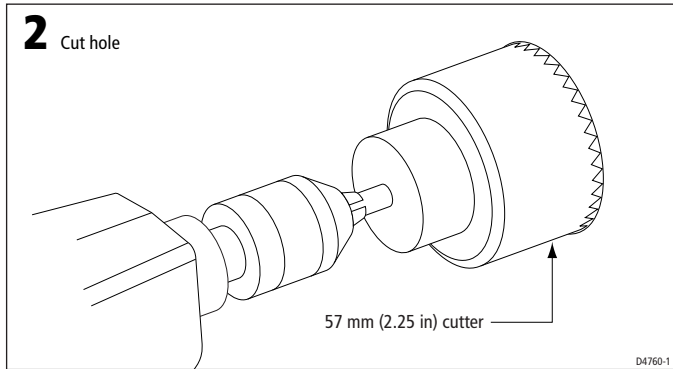

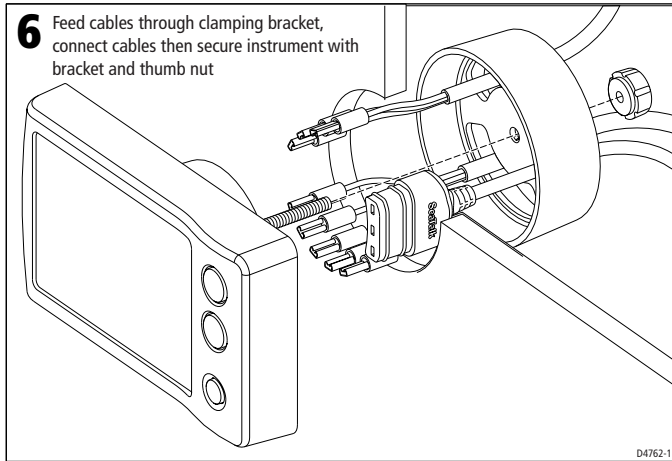
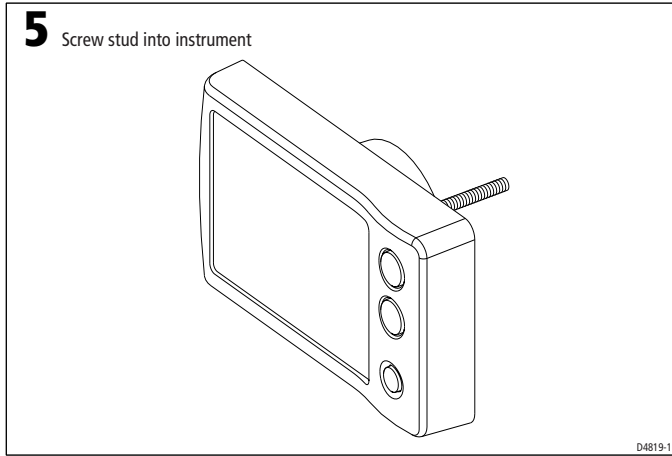

Desktop Mounting Bracket

An optional Desktop Mounting Bracket (Part No. E25024) enables you to mount your ST40 instrument in locations where other forms of mounting are impractical.

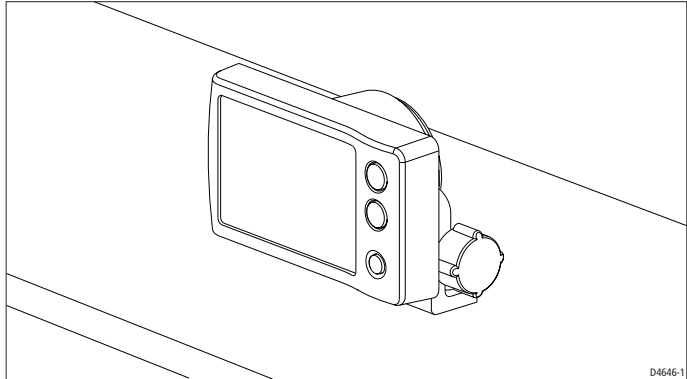

To bracket mount your ST40 instrument, do so in accordance with the *Instruction Sheet*, which is included with the Desktop Mounting Bracket.

3.3 Calibration requirement

Once installation is complete and before you use your instrument, carry out the calibration procedures detailed in *Chapter 4, Calibration*.

Chapter 4: Calibration

4.1 Introduction

The procedures in this Chapter must be carried out before the equipment is used operationally, to optimise the performance of the instrument with the vessel.

Calibration information is presented in flow chart form. The flow charts show the various calibration screens and key presses necessary to carry out calibration. All key presses are momentary unless otherwise stated.

EMC conformance

- Always check the installation before going to sea to make sure that it is not affected by radio transmissions, engine starting etc.

4.2 User calibration



User calibration enables you to:

- Set the required units for speed readings. Either KTS (knots), MPH (miles per hour) or KPH (kilometres per hour).
- Select temperature units. Either °C or °F, as required.
- Set the speed display response. Use higher response values when boating in conditions requiring rapid updates of the current speed (e.g. competition sailing or on power boats). Use slower response values when you require an average speed over a longer period of time (e.g. when cruising, especially in heavy seas).
- Set the correct speed reading, either by using a **Cal factor** screen to adjust the calibration factor, or by applying Speed Over Ground (SOG) as the current speed. Your vessel must be moving at 0.5 KTS or more and be receiving SeaTalk SOG data, to enable SOG to be applied as the current speed. This should be done only in conditions of zero tide and current.
- Set the depth display response. Use higher response values when boating in conditions requiring rapid updates of depth information (e.g. inshore, especially when travelling at high speed). Use slower response values when you require an average depth over a longer period of time (e.g. deep sea cruising).
- Set the required units for depth readings. Either FT (feet), M (metres) or FA (fathoms).

- Set the required depth offset.
- Lock the shallow alarm, to prevent unauthorised changes during normal operation.

Power up the instrument then follow the procedure in the *User calibration* flow diagram. This diagram shows the User calibration sequence for an ST40 Bidata operating as a master instrument for both speed and depth .

USER CALIBRATION (sheet 1)

During normal operation
hold down  and  for approximately 2 seconds

Entry screen

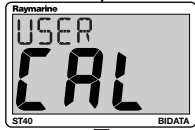

Note:
If there is no key activity when the **Entry screen** is displayed, calibration will time out to normal operation after 5 seconds,

Depth response



From **Shallow alarm lock** screen (sheet 2)

Speed response

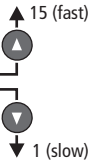

Depth units

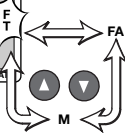
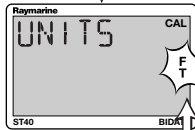

Speed units

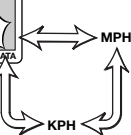
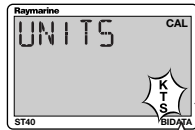

To save your settings and return to normal operation from any screen, hold down



for approximately 2 seconds

To **Distance units** screen (sheet 2)

USER CALIBRATION (sheet 2)

From **Speed units** screen (sheet 1)

Distance units

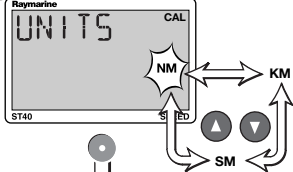

Temperature units

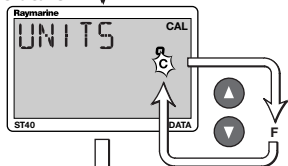

2.5 (increase speed)
0.25 (decrease speed)

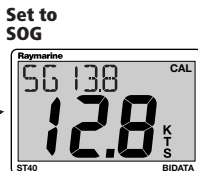
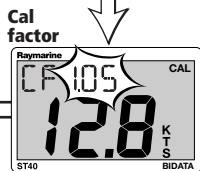

Displayed only if SOG available on SeaTalk & vessel speed greater than 0.5 kt. To apply SOG value as speed reading, press

▲ for 3 seconds in conditions of zero tide and current

Depth offset

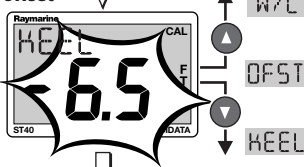

WARNING: Correct offset values are essential to ensure the safe operation of the vessel. If you are not sure how to set the correct values, refer to the additional information given in the text accompanying this

To **Depth response** screen (sheet 1)

Shallow alarm lock

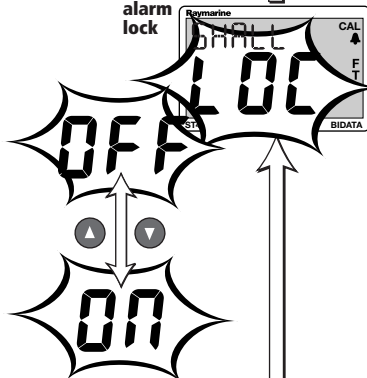

To save your settings and return to normal operation from any screen, hold down ▼ and ▲ for approximately 2 seconds

Depth offsets

WARNING:

The use of incorrect offset values could result in misleading depth information being displayed with a consequent risk of running aground.

The depth offset screen enables you to determine the exact point on the vessel from which depths are measured. This point can be:

- **The transducer.** Set offset to zero. With zero offset applied, the screen header is OFST.
- **The bottom of the keel.** Set a negative offset equal to the vertical distance between the transducer position and the bottom of the keel. With a negative offset applied, the screen header is KEEL.
- **The water line.** Set a positive offset equal to the vertical distance between the transducer position and the water line. With a positive offset applied, the screen header is W/L.

4.3 Intermediate calibration

Intermediate calibration enables you to:

- Check the instrument software version.
- Check and if necessary set, the instrument status - either MASTR (master) or REPTR (repeater), for both speed and depth.

Follow the procedure in the *Intermediate calibration* flow diagram.

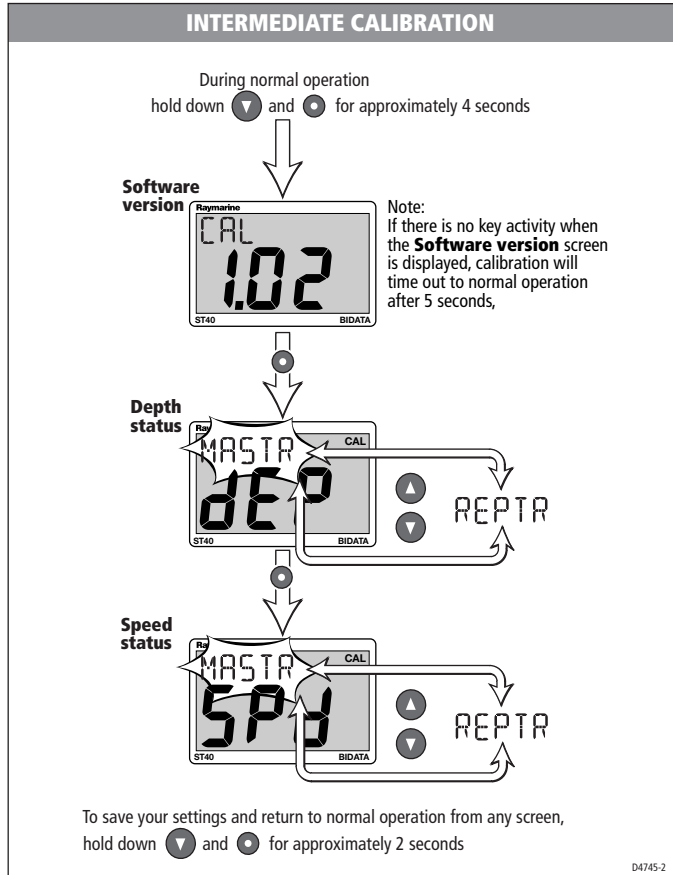

4.4 Dealer calibration



Dealer calibration enables you to set:

- User calibration on/off.
- Boat show mode on/off.

Dealer calibration also gives access to the **Factory defaults** screen. This enables you to reapply the factory settings if you want to reset the instrument to a known operating condition.

Follow the procedure in the *Dealer calibration* flow diagram.

DEALER CALIBRATION

During normal operation
hold down  and  for approximately 12 seconds

Entry screen

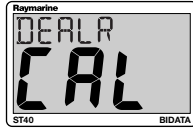

Note:
If there is no key activity when the **Entry screen** is displayed, calibration will time out to normal operation after 5 seconds,

Calibration access

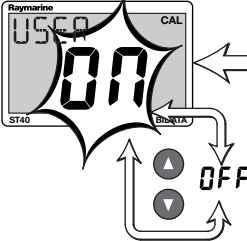

Boat show mode

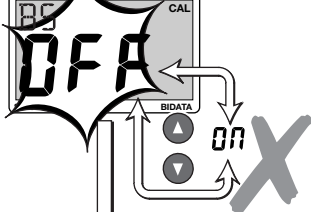

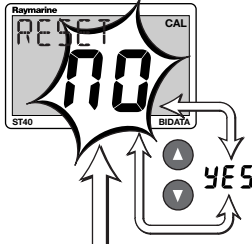

CAUTION:
Do NOT switch the Boat Show mode on. This function must only be used for demonstration purposes.

Factory defaults



Return to normal operation with factory defaults set

To save your settings and return to normal operation from any screen,
hold down  and  for approximately 2 seconds

Instrument Specification

Supply voltage:	10 V to 16 V dc.
Current consumption (12 V supply):	35 mA typical. 70 mA with maximum backlighting.
Operating temperature:	0°C to +70°C.
Interfaces:	SeaTalk.
Overall dimensions:	126 mm x 70 mm x 38 mm (5.00 inches x 2.80 inches x 1.55 inches).
Boss diameter:	55 mm (2.20 inches).
Speed range:	0 to 99.9 knots.
Log range:	0 to 99999.
Trip reading range:	0 to 999 nautical miles.
Temperature reading range:	-10°C to +40°C.
Depth range:	0 to 400 feet.
Shallow depth alarm:	0 to 29 feet.
Deep depth alarm:	30 to 400 feet.
Shallow anchor alarm:	1 to 250 feet.
Deep anchor alarm:	10 to 400 feet.
Approvals:	
CE - conforms to	89/336/EC(EMC), EN60945. 94/25/EC(RCD), EN28846 (applies to transducer only).

Glossary

Cal factor	Calibration factor. Used in the ST40 Speed and Bidata instruments to ensure the current speed reading is the actual speed. Values are from 0.25 (reduce speed reading) to 2.5 (increase speed reading).
EMC	Electromagnetic Compatibility.
FA	Fathoms.
FT	Feet.
KEEL	When displayed on the Offset screen (during normal operation), or the Depth offset screen (during User calibration), indicates that a negative depth offset is set.
KPH	Kilometres per hour.
KTS	Knots.
M	Metres.
MPH	Miles per hour.
OFST	When displayed on the Offset screen (during normal operation), or the Depth offset screen (during User calibration), indicates that a depth offset value of 0 is set.
Response	The rate at which an instrument responds to changes in speed and depth. Values are from 1 (slow response) to 15 (fast response).
SeaTalk	SeaTalk is a proprietary Raymarine system which links different compatible products, to provide a single, integrated navigational system. SeaTalk can also communicate with non-SeaTalk equipment using the internationally- accepted National Marine Electronics Association (NMEA) protocol. Contact your Raymarine dealer for details.
W/L	When displayed on the Offset screen (during normal operation), or the Depth offset screen (during User calibration), indicates that a positive depth offset is set.

Index

A

- Alarms 7–8
 - enable/disable 8
 - indications 7
 - ranges 35
 - setting thresholds 4–5
 - silencing 2
 - switching on and off 4–5
- Average speed reset 2, 3

B

- Backlighting 6
- Boat show mode 32

C

- Calibration 27–33
 - Dealer 32–33
 - Intermediate 31–32
 - setting appropriate response values 27
 - setting user access 33
 - User 27–31
 - User calibration screen sequences 31
- Calibration requirement 1, 26
- Cleaning the instrument 10
- Condensation 9
- Connecting the instrument 21
- Contrast 6
- Current consumption 35

D

- Dealer calibration 32–33
- Depth
 - alarms 4–5
 - appropriate response values 27
 - offset 5, 28, 30, 31
 - range 35
 - reading flashing 11
 - response 27, 29
 - units 27
- Desktop Mounting Bracket 25–26
- Dimensions 35

Display

- backlighting 6
- contrast 6
- selecting speed or data display 2

E

- EMC
 - conformance i, 27
 - installation guidelines 15–16

F

- Factory defaults 32
- Fault finding 10
 - assistance 13
 - blank display 11
 - depth reading flashing 11
 - low battery 10
 - no depth information 11
 - no speed information 12
 - no speed or temperature information 12
 - SeaTalk problems 13

I

- Installation 15–26
 - connecting the instrument 21
 - EMC guidelines 15
 - fitting the instrument 23–26
 - planning 15–19
 - site requirements 17–20
 - tools required 16–17
 - transducers 20
- Instrument
 - cleaning 10
 - condensation 9
 - connecting 21
 - current consumption 35
 - fitting 23–26
 - site requirements 19
 - status (master or repeater) 31
 - supply voltage 35
- Intermediate calibration 31–32

L

- Log
 - range 35
- Log distance 2
- Low battery indication 10

M

- Maintenance 9–10
- Maximum speed reset 2, 3
- Minimum depth reset 2, 4

N

- Normal operation 3–6

O

- Offset 5, 28, 30, 31
- Operation 1–8

P

- Panel lighting 6
- Parts supplied vi

R

- Reset
 - average speed 2, 3
 - maximum speed 2, 3
 - minimum depth 2, 4
 - trip distance 3
- Response values
 - depth 27
 - speed 27

S

- Servicing and safety 9
- Setting
 - alarm thresholds 4–5
 - backlighting 6
 - calibration factor 30
 - contrast 6
 - correct speed 30
 - depth offset 30–31
 - depth response 29
 - depth units 29
 - shallow alarm lock 29
 - speed response 29
 - speed units 29
- Shallow alarm lock 29

- Site requirements 17–20
 - instrument 19
 - transducers 17–20
- Software version 31
- Specifications 35
- Speed
 - appropriate response values 27
 - calibration factor 37
 - range 35
 - response 27
 - units 29

T

- Temperature reading range 35
- Transducers
 - fitting 20
 - site requirements 17–20
- Trip distance
 - range 35
- Trip distance reset 3

U

- User calibration 27–31
 - screen sequences 31

V

- Voltage 35

